

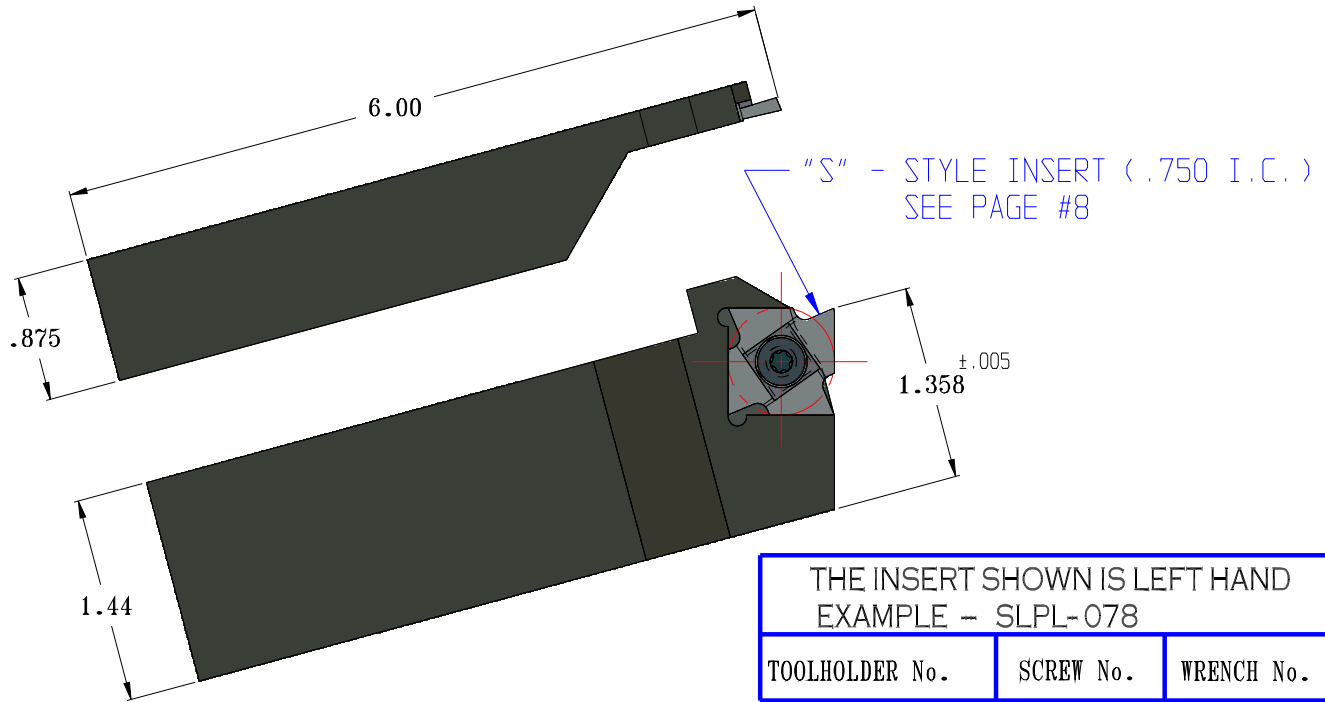

NEW BRITAIN CUT-OFF TOOLHOLDERS



PATENT No. D307859



THE INSERT SHOWN IS LEFT HAND
EXAMPLE - SLPL-078

TOOLHOLDER No.	SCREW No.	WRENCH No.
NBSR-56	CTD-3341	CTD-3342

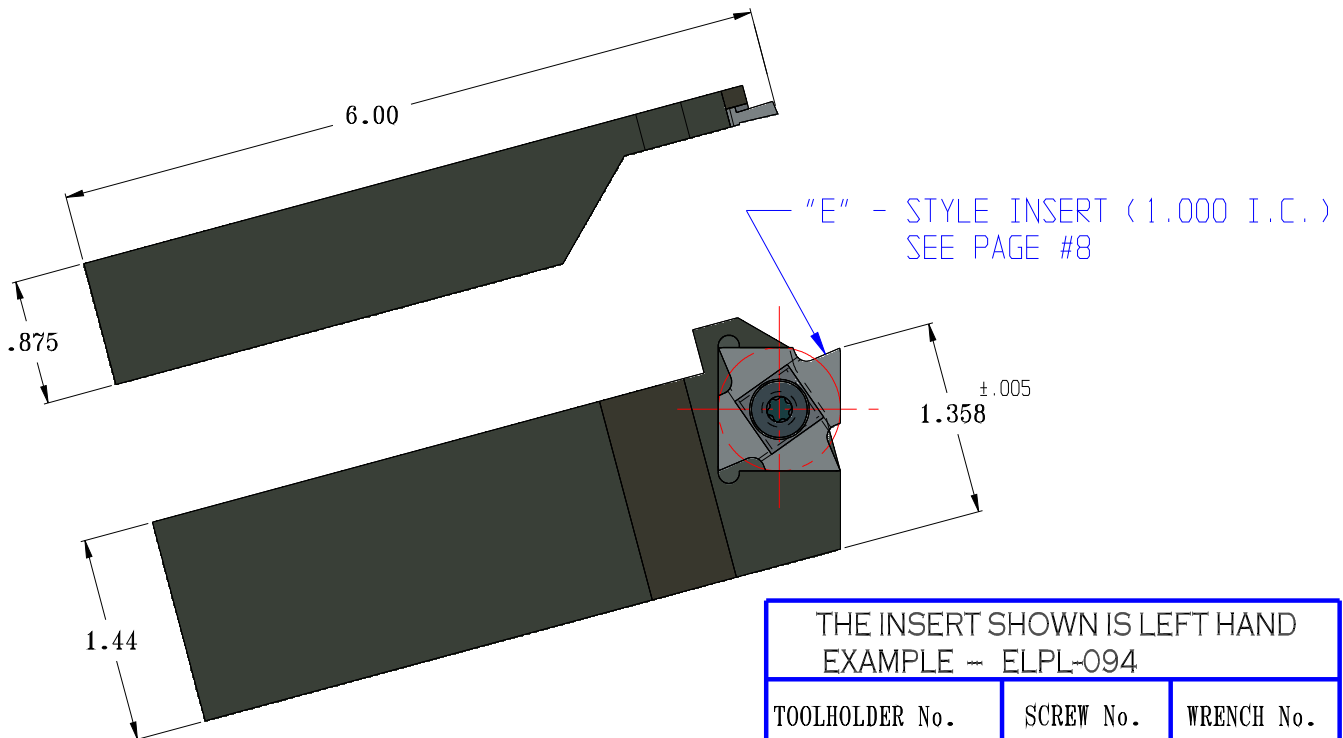

THE INSERT SHOWN IS LEFT HAND
EXAMPLE - ELPL-094

TOOLHOLDER No.	SCREW No.	WRENCH No.
NBSR-80	CTD-4857	CTD-3342